



Contents

Safety Precautions	3
Important Safety Information	3
Getting Started	4
Installation	5
Operating Instructions	11
Navigating the On Screen (OSD) Menu.....	13
Specifications	18
Input Mode	19
Troubleshooting.....	20
Dimensions.....	21

Safety Precautions

CAUTION	
	Do not install the display near flammable objects such as gasoline or other volatile liquids.
	Do not install the display near any heat sources such as radiators or other heating devices.
	Do not damage the power cord or plug.
	Do not disassemble the screen to avoid electric shock.
	The product can normally be operated at an altitude under 2000m. Abnormalities may occur when installing the device at an altitude above 2000m.



WARNING	
	The display should be installed in a well-ventilated place, do not install it in a confined space.
	Unplug the power cord before cleaning the device.
	If you smell smoke or hear strange noises, immediately unplug the monitor and contact the vendor.
	Do not discard this product with general household waste. Be sure to comply with the local waste regulations for disposal.
	Suitable for mounting on concrete and non-combustible surface only.

IMAGE BURN-IN WARNING	
	When a stationary or fixed image is displayed on the screen for a long time, the image may be permanently imprinted on the screen. This phenomenon is known as image burn-in and is not covered by the manufacturer's warranty.
	In order to avoid burn-in, avoid prolonged display of static or fixed images on the screen

Important Safety Information

- Do not place heavy objects on the power cord. A damaged power cord might cause electric shock or fire.
- Do not bend, twist, or damage the power cord.
- The power cord must comply with the local safety regulations.
- Do not damage or modify the prongs/pins and the ground contact on the power cord plug.
- Do not place the LCD on an unlevelled surface or an unstable vehicle. The LCD could fall over and cause substantial damage.
- Do not cover the vents and/or the heat sink.
- Do not install the LCD beside radiators or other heat sources. The installation site should have sufficient ventilation so the heat generated by the LCD can be dissipated.
- Handle the LCD with care. Save the packaging materials for transport later.

Unplug the LCD immediately and contact vendor as soon as possible when any of the following situations occur:

- Damaged power cord or power plug.
- If liquid or foreign object has entered the LCD.
- If the LCD has been dropped or the casing has become damaged.
- If any structural damage such as cracks or unnatural vibration is found.
- If the LCD cannot be operated following the steps outlined in this manual.
- If the LCD emits smoke or other odors, or generates strange noises.

Operating Suggestions:

- Avoid displaying a stationary image for a long period of time in order to prevent image sticking.

Getting Started

Contents

Confirm that the accessories below are shipped along with the display. If any item is missing, please contact your dealer.

- 55" IP56 Display
- Remote Control
- (2) Batteries (1.5V / AAA)
- RS-232 cable
- DVI cable
- Ethernet crossover cable
- (6) 4-40 x 3/8" Flat Head Screws

Installing and Replacing Remote Control Batteries

1. Open the battery compartment cover.
2. Insert 2 new AAA batteries
3. Close the battery compartment cover.

Warning:

- Incorrect usage of batteries may cause leakage or explosion.
- Pay attention to the polarity when installing the batteries.
- Do not mix different types of batteries or new and used batteries. Doing so may shorten the battery life or cause leakage.
- Remove or replace the batteries when they are empty in order to prevent acid leaking in the battery compartment
- Do not touch the leaked substance from the batteries in case of a battery leakage. Doing so may hurt human skin.

Note: If the remote control is not going to be used for a long time, we recommend removing the batteries from the remote control.

Installation

- 1 Remove back cord grip cover.

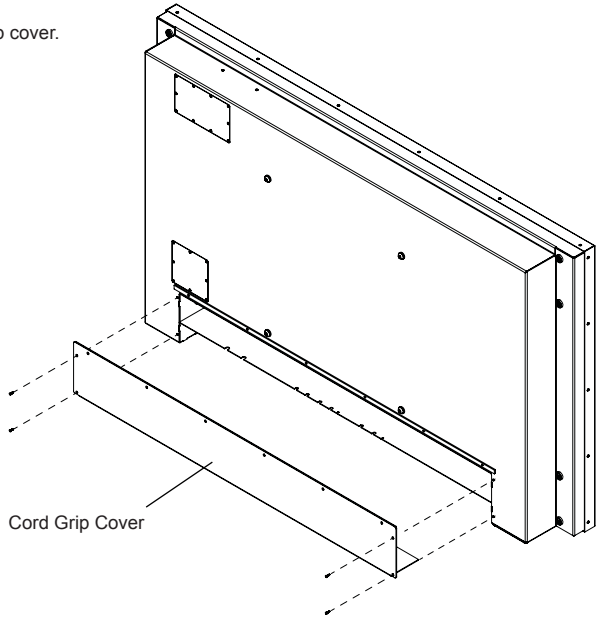

- 2 Refer to the remaining sections of the instruction manual to properly setup your display. Once the display is completely setup and ready to use, peel off the release liner on the Butyl Tape shown below (McMaster part #76385A32) and re-attach the Cord Grip Cover using (10) 4-40 Flat Head Screws.

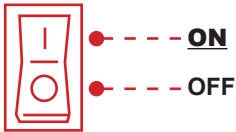

Note: Once the release liner is removed and the Cord Grip Cover is re-attached the display will be sealed. Make sure all cables needed are plugged into the display and the power switch is turned to the "ON" position before reattaching the Cord Grip Cover.

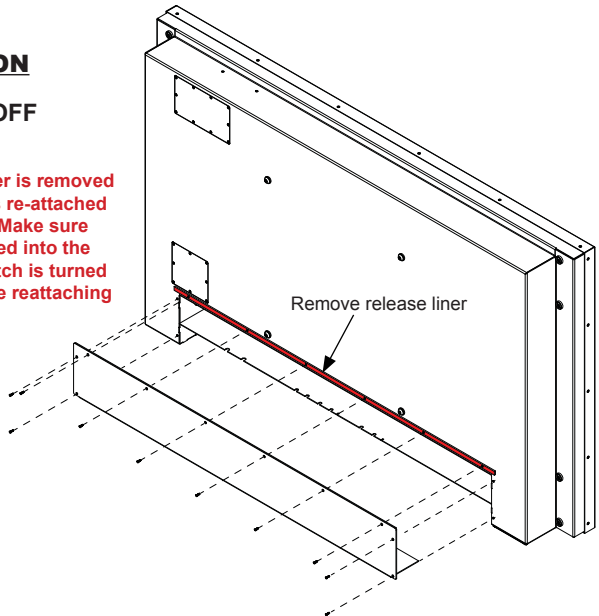

Installation

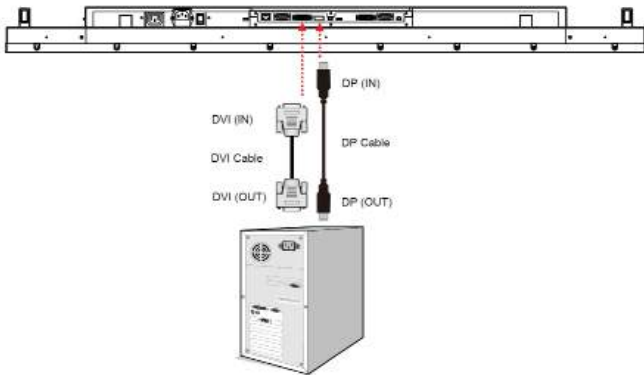

Connecting Multiple Displays for Video Wall Applications

To daisy chain multiple displays for a video wall application, connect a video source to the 1st display into the chain with the supplied DVI cable (or DP cable) and RS-232 cable. Connect the DVI-OUT of the 1st display to the DVI-IN of the 2nd display. Using the RS-232 cable provided, connect the RS-232 OUT of the 1st display to the RS-232 IN of the 2nd display. Repeat the connection for the remaining displays. Use the OSD Menu or Display Manager software to configure the size of the video wall and the position of each display.

Note:

- The maximum number of displays in a Video Wall is 36.
- The DynaScan "Display Manager" application is required to be installed on the PC in order to use the External Control feature
- The Daisy Chain Setting (video wall function) only supports a resolution of 1920p x 1080p.

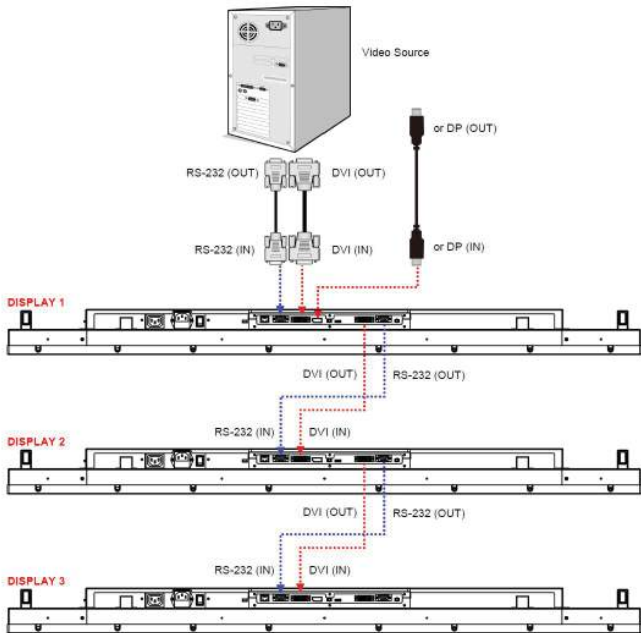

Connector Positions

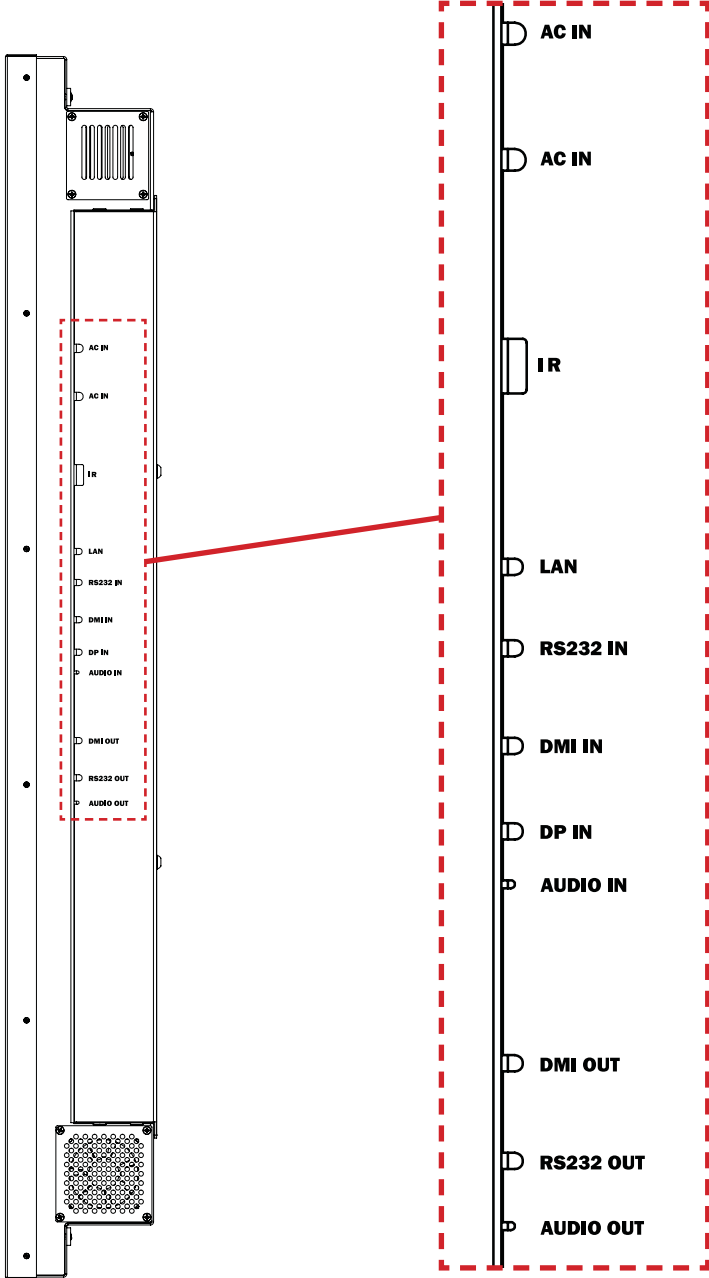

Installation

Input / Output Terminals

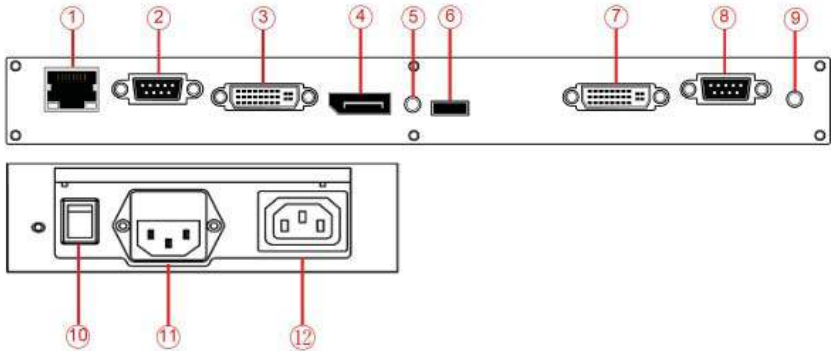

1. **RJ-45 (IN):** RJ45 network input connection for remote control from PC.
2. **RS-232 (IN):** RS232C network input connection for remote control from PC.
3. **DVI (IN):** Connect the DVI-D output of a PC, or the HDMI output of an AV device via a DVI-HDMI cable.
4. **DP (IN):** Connect the DP output of a PC, or the DP output of an AV device via a DP cable.
5. **Audio (IN):** Connect the audio input from an external AV device.
6. **Extension Connector:** Extension Connector for optional IR Extension sensor kit (ESK201).
7. **DVI (OUT):** Output the signal from DVI IN.
8. **RS-232 (OUT):** RS232 control function for daisy chain application.
9. **Audio (OUT):** Connect the audio signal output from Audio IN jack to an external AV device.
10. **Power Switch:** Press to switch the main power on/off.
11. **AC (IN):** Connect the supplied power cord to the wall outlet.
12. **AC (OUT):** AC outlet 110~220V up to 100 Watt.

Installation

The LCD must be properly installed using a wall mount. Incorrect installation may cause injury or damage the equipment. Product warranty does not cover the damage caused by improper installation.

Mounting

- Hanging the Professional LCD from the ceiling or mounting it on the wall is the responsibility of the user. Not all ceilings or walls provide enough strength to support the LCD. The LCD may drop and cause serious injury if it is hanging from the ceiling with insufficient support or is mounted on a slanted wall. Product warranty does not cover improper installation, modification, or damage caused by natural disasters. It is recommended to have a certified professional to evaluate the installation site and perform the mounting operation.
- Do not cover the vent and/or the heat sink in order to ensure proper heat dissipation.
- Refer to the installation guide provided by the manufacturer for proper mounting.

When mounting on a wall or hanging from a ceiling

- A wall mount is not included in the accessory. Please purchase a VESA Standard wall mount to secure the LCD.
- Verify that the mounting location can support the weight of the LCD before installation.
- Do not install the wall mount while the power is turned on as it may cause serious injury due to a electrical shock.

VESA (mm)	Screw Specification	Screw Length	Number
400 x 400	M8	Greater than 10mm Smaller than 16mm	4

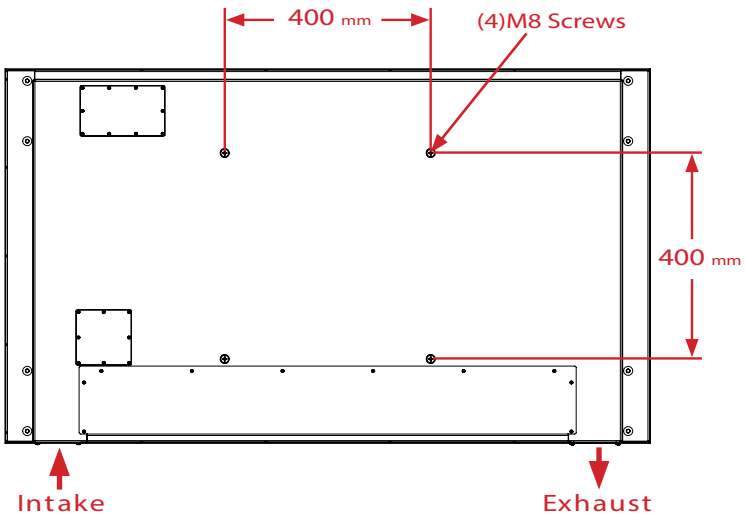

MOUNT DISPLAY IN LANDSCAPE ORIENTATION ONLY

Warning:

- The IP56 Display is **ONLY** intended to be mounted in a landscape orientation. **DO NOT MOUNT DISPLAY IN PORTRAIT ORIENTATION.**
- Make sure intake and exhaust ports are facing downward and are clear of any obstruction.

Installation

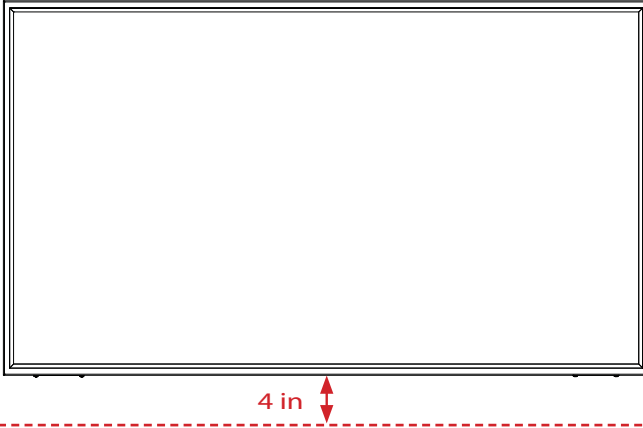

Allow a minimum of 4" clearance beneath the display to allow for proper ventilation.

When hanging from a ceiling

- Ensure that the ceiling is strong enough to support the LCD and its accessories. Earthquake, unexpected vibration and other external forces should be taken into consideration when evaluating the ceiling strength.
- The LCD should be secured to the building's structural frame such as a beam rather than light steel frame or interior decoration.
- Do not use wood screws or dry wall anchors for installation.

Maintenance

- Inspect the fasteners regularly for signs of loosening or deformation. Please perform appropriate corrective measures when a problem is identified. Neglecting the problem may worsen the situation.
- Increase the inspection frequency on areas where previous maintenance had occurred to ensure the problems do not occur again.

Using the Remote Control

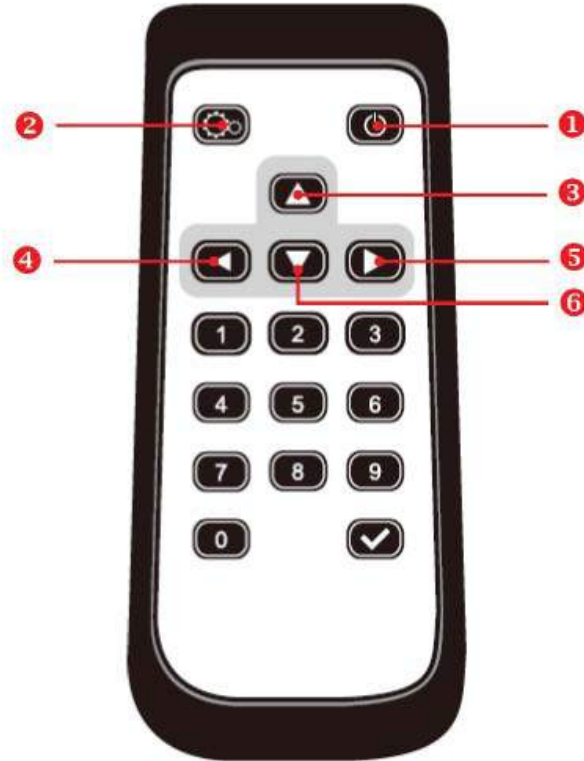

Item		Description
1	POWER	POWER ON / OFF
2	MENU	OSD ON / OFF
3	UP	MOVE THE CURSOR UP OR CHANGE THE SETTING OF SELECTED ITEM
4	LEFT	EXIT THE CURRENT SELECTION.
5	RIGHT	SELECT THE HIGHLIGHTED ITEM.
6	DOWN	MOVE THE CURSOR DOWN OR CHANGE THE SETTING OF SELECTED ITEM

Using the Rear Panel Controls

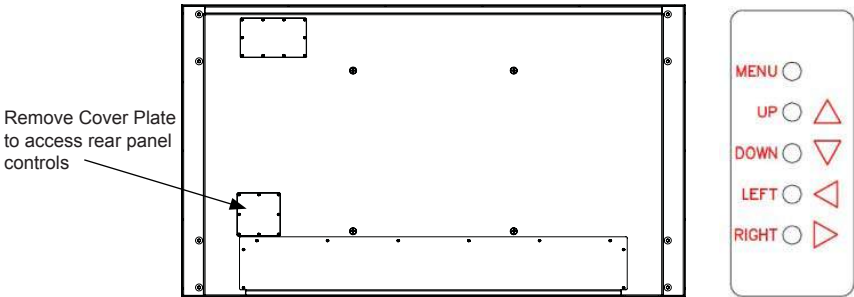

Item		Description
1	POWER	POWER ON / OFF
2	MENU	OSD ON / OFF
3	UP	MOVE THE CURSOR UP OR CHANGE THE SETTING OF SELECTED ITEM
4	LEFT	EXIT THE CURRENT SELECTION.
5	RIGHT	SELECT THE HIGHLIGHTED ITEM.
6	DOWN	MOVE THE CURSOR DOWN OR CHANGE THE SETTING OF SELECTED ITEM

Navigating the On Screen Display (OSD) Menu

Press the MENU button on either the rear panel control or remote control to show the OSD. Use the navigation arrows to select and adjust the menu items.

Input Source	Main	DP
Picture	Failover	DVI
Time		
Video Wall		
Backlight		
Network		
Advance		

Item 1	Item 2	Default	Description
Input Source	Main	DP	Set the Main input to display. (DP(Display Port) or DVI)
	Failover	DVI	Set the Failover input to display. (DP(Display Port) or DVI)

Input Source	Color Temperature	User
Picture	R	100
Time	G	100
Video Wall	B	100
Backlight	Contrast	50
Network	Gamma	Native
Advance		

Item 1	Item 2	Default	Description
Picture	Color Temperature	D65	Select the color temperature. (User, D93, D65 and D55).
	R	100	Adjust the red light level. Range 0 – 100. Note: The feature is only supported on User mode.
	G	100	Adjust the green light level. Range 0 – 100. Note: The feature is only supported on User mode.
	B	100	Adjust the blue light level. Range 0 – 100. Note: The feature is only supported on User mode.
	Contrast	50	Adjust the contrast level. Range 0 – 100.
	Gamma	Native	Adjusts the Gamma value.

Navigating the On Screen Display (OSD) Menu

Input Source	Current Time	10:00
Picture	Power Control Timer	Off
Time	Power On Time	00:00
Video Wall	Power Off Time	00:00
Backlight		
Network		
Advance		

Item 1	Item 2	Default	Description
Time	Current Time	HH:MM	Set the clock. Note: The internal clock will continue to function when the power is turned off.
	Power Control Timer	Off	Turn on / off automatic power schedule
	Power On Time	HH:MM	Set turn-on time
	Power Off Time	HH:MM	Set turn-off time

Input Source	Number of Rows	01
Picture	Number of Columns	01
Time	Row Position	01
Video Wall	Column Position	01
Backlight	Bezel Compensation	On
Network		
Advance		

Item 1	Item 2	Default	Description
Video Wall	Number of Rows	1	Set number of rows in a video wall. Note: The maximum number of rows in a daisy chain is 15
	Number of Columns	1	Set number of columns in a video wall. Note: The maximum number of columns in a daisy chain is 15
	Row Position	1	Vertical position in a video wall.
	Column Position	1	Horizontal position in a video wall.
	Bezel Compensation	On	Choose to turn the frame compensation function on or off. When turned on, the display will adjust the image to compensate the width of display bezels in order to accurately display the image.

Navigating the On Screen Display (OSD) Menu

Input Source	Auto Brightness	Off
Picture	High Level	100
Time	Low Level	20
Video Wall	High Level Time	00:00
Backlight	Low Level Time	00:00
Network	Local Dimming	Medium
Advance		

Item 1	Item 2	Default	Description
Backlight	Auto Brightness	Off	To turn On / Off the auto brightness adjustment. Note: If the AUTO BRIGHTNESS is off, the screen brightness will remain at HIGH LEVEL brightness value. If the AUTO BRIGHTNESS is on (Auto), the display brightness adjusts according to the ambient light. When ambient light is bright, the screen will adjust to the HIGH LEVEL brightness value set; when ambient light is dark, the screen will adjust to the LOW LEVEL brightness value set. When the Timer mode is set, the display will automatically switch the brightness according to the time set.
	High Level	100	Adjust the highest brightness leve. Range 0-100
	Low Level	20	Adjust the lowest brightness level. Range 0-100
	High Level Time	HH:MM	Set high level time.
	Low Level Time	HH:MM	Set low level time.
	Local Dimming	Medium	Adjust the contras. High is the highest contrast. Off is the lowest contrast.

Input Source	DHCP	On
Picture	IP	192.168. 0.100
Time	Mask	255.255.255. 0
Video Wall	Gateway	192.168. 0. 1
Backlight		
Network		
Advance		

Item 1	Item 2	Default	Description
Network	DHCP	On	Choose to enable or disable the DHCP function. If enabled, the display will assign the IP address, Subnet mask and Default gateway automatically. If disabled, the following values will be entered manually.
	IP	192.168.0.100	Assign IP address.
	Mask	255.255.255.0	Assign Subnet mask.
	Gateway	192.168.0.1	Assign Default gateway

Navigating the On Screen Display (OSD) Menu

Input Source	Display Mode	Landscape
Picture	Screen Saver	Off
Time	Remote Control	RS232
Video Wall	IR Control	On
Backlight	Power Off Mode	Standby
Network	Black Level	Limited
Advance	Reset to Default Setting	Off

Item 1	Item 2	Default	Description
Advance	Display Mode	Landscape	Change the Menu orientation. The Menu can be displayed in either LANDSCAPE or PORTRAIT mode.
	Screen Saver	Off	Turn on / off image burn-in protection. Set image burn-in protection interval.
	Remote Control	RS232	Choose to use the remote control function RS232 or Network.
	IR Control	On	Enable/disable the remote control for Menu. Note: When disabled, the remote control function can be enabled again from the control panel on the display or through the DynaScan "Display Manager" application.
	Power Off Mode	Standby	When in Power Off Mode, RS-232 controls do not function. Only [Main Power Switch] on the display or [Power Button] on the remote control can wake up the display.
	Black Level	Limited	Selects the black level to adjust the screen gray scale. "Limited" for video source uses 16 to 235 levels for R/G/B, such as HDMI. "RGB Full" for video source uses all levels from 0 to 255 levels.
	Reset to Default Setting	Off	Restore all settings to default. Note: It does not modify CURRENT TIME, POWER ON TIME and POWER OFF TIME.

Navigating the On Screen Display (OSD) Menu

Information 1	Resolution	DP 1920x1080
Information 2	Model	DS552LT4
	Serial Number	552LT4XXXXXXXXXX
	Over Heat Protection	Mode 0
	Fan Alarm	

Item 1	Item 2	Default	Description
Information 1	Resolution	1920x1080	Input resolution.
	Model	DS552LT4	The display's model.
	Serial Number		The display's serial number.
	Over Heat Protection	Not displayed	It will enter into protection mode when the display internal temperature is over heat. Mode 0 = Brightness 50%. Mode 1 = Brightness 25%. Mode 2 = Brightness 03%. When the temperature is decreased to exit the protection, the brightness will restore to 100% and Over Heat Protection is disabled.
	Fan Alarm	Not displayed	When any of the cooling fans on the display rear side is failure and stops running, the Fan Alarm will appear and blink, and reduce the brightness to 25%. Be sure to contact the service engineer for repair.

Information 1	Hardware	XXXXX
Information 2	Firmware	X.X.X

Item 1	Item 2	Default	Description
Information 2	Hardware		The H/W version.
	Firmware		The F/W version.

Some functions may not be available for all models.

* Adjusted value: Each R/G/B value for this product has been individually adjusted during production to a preset color temperature of 6500K.

Specifications

Model		DS552LT4
Panel	LCD Panel Size	56.64 inches
	Native Resolution	1920 x 1080
	Brightness	3500 cd/m ² (Typ.)
	Contrast Ratio	3,000:1 (Static) 10,000,000:1 (Dynamic)
	Response Time	9ms (Typ.)
	Viewing Angle	178°/178°
	Life Time	100,000 hrs (Typ.)
	Panel Surface	AR 1.5%, 2H
Power	Power Supply	Internal
	Rated Voltage	100~240V, 50 / 60Hz
	Power On Mode	Typ. 205W / Max. 290 W
	Standby Mode	< 1W
	AC Out	< 100W
Mechanical Specs	Bezel Width	.86in (21.7mm) all around
	Cabinet Color	Black
	Monitor Dimensions (LxHxD)	49.3in x 28.6in x 5.9in
	Monitor Weight	95 lbs
	VESA Mounting	400 x 400
User Interface	OSD Language	English
Environment	Operation Temperature	-40C - 50C
	Storage Temperature	-40C - 60C
	Humidity	80% Non-Condensing
Fuse		5A

- Design and specifications are subject to change without notice
- The resolution of DVI-D out is 1920 x 1080 (1080p) only.

Input Mode

Active Resolution		Refresh Rate	Pixel Rate	Aspect Ratio
H Pixels	V Lines			
640	480	60 Hz	25.175 MHz	4:3
720	480	50 Hz	27 MHz	4:3
		59.94 Hz	27 MHz	4:3
800	600	60 Hz	40 MHz	4:3
1024	768	60 Hz	65 MHz	4:3
1280	720	50 Hz	74.25 MHz	16:9
		60 Hz		
1280	768	60 Hz	79.5 MHz	5:3
1360	768	60 Hz	85.5 MHz	16:9
1920	1080	50 Hz	148.5 MHz	16:9
		60 Hz		

Troubleshooting

Issue	Recommended Solution
No image is displayed	<ul style="list-style-type: none">• Check whether the DVI in cable is completely plugged in.• Check whether the main switch is in the ON position, and the power cord is completely plugged in.• Check whether the image source's resolution is set to 1920 x 1080 (1080p).• Check whether the DVI cable is damaged or bent excessively.
Nothing happens when switching the main switch on.	<ul style="list-style-type: none">• Unplug the power cord from the socket and plug it in again after a few seconds to reset the Signage. Note: Unplugging the power cord will not change the settings.
Image is unstable.	<ul style="list-style-type: none">• Check whether the DVI in cable is completely plugged in.
The remote control does not work.	<ul style="list-style-type: none">• Check whether there are batteries in the remote control.• Check the batteries for freshness, polarity, etc.• Check whether the remote is in the operation range.• Bright light may interfere with the remote control. Please avoid using the remote control near special fluorescent lights or neon lights.
Auto on/off does not work or does not function properly.	<ul style="list-style-type: none">• Check whether the TIMER setting in the menu is set to "OFF".• Check whether the "Power On Time" and "Power Off Time" settings are set correctly.
Cannot control the display remotely via RS-232	<ul style="list-style-type: none">• Check whether the RS-232 cable is connected properly.

If you are still having trouble with your IP56 Display, contact your dealer directly for more assistance.

Dimensions

