



**Professional Solutions - Unrivalled Value**

Ideal for components weighing up to 50lb (22.7kg) and may be used with wall mounted TV or as a stand-alone wall unit. Easy to install, with limitless shelf height adjustment. 6mm tempered glass that sits only 1.18" from the wall. Integrated cable management for a clean look.

 50 LB / 22.7 KG

**Functional Specifications**

**Depth from wall:** 1.18" (30mm)

**Mounting Surfaces:** Wood stud, concrete & cinder block (with included hardware). Drywall (requires accessories).

**Load Capacity:** 50 LB / 22.7 KG

**Warranty:** Limited 10 Years



**Adjustable Shelf**  
Limitless height adjustment without use of tools.



**Cord Management**  
Integrated cord management for clutter-free installation.



**Flexibility**  
Choose between one, two or three shelves for a custom wall system.

- **Appearance**  
Black smoke tempered glass.
- **Adjustable**  
Continuous height adjustment, no tools required.
- **Easy Installation**  
Mounts to a single stud, concrete or other structural surface. Also may be mounted directly on drywall using the HT2 hardware pack.
- **Cable Management**  
Integrated cable management for clean look.
- **Included Hardware**  
Pre-sorted hardware pack for easy component selection and installation (hardware for installation to wood studs or concrete surfaces included).



# WA Series Shelf System

For components weighing up to 50lb

WA1  
WA2  
WA3

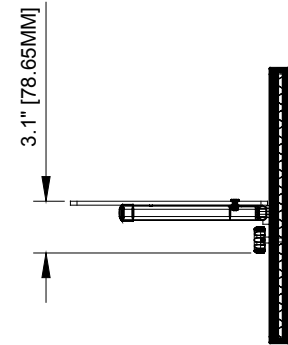
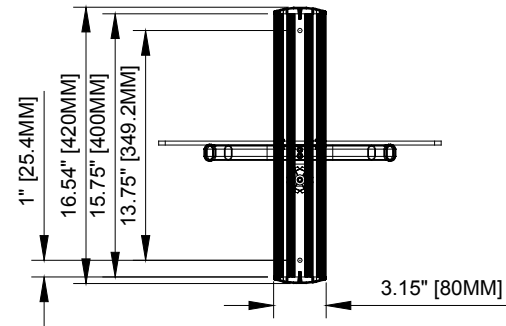
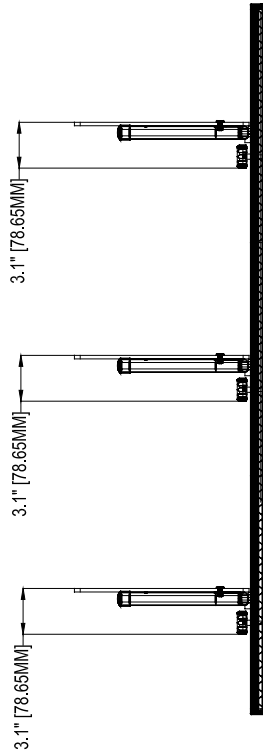
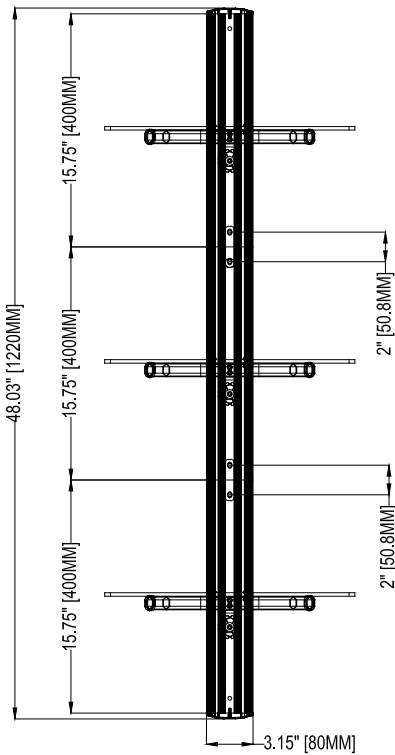
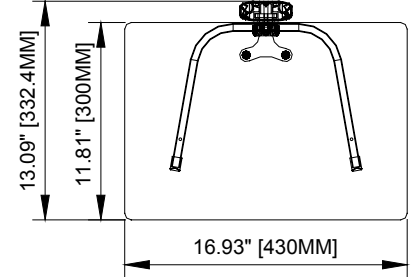
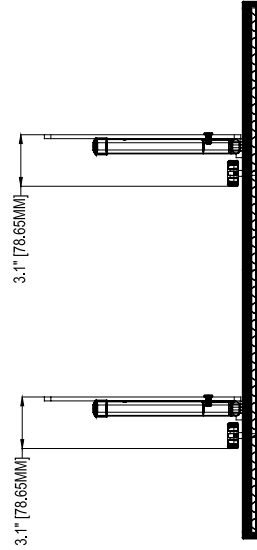
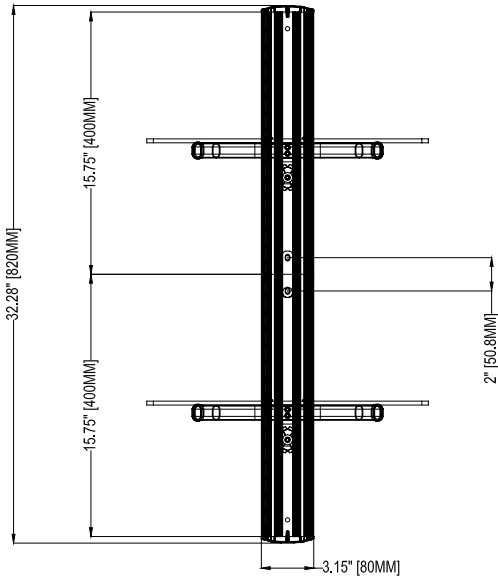

## Product Specifications

## Package Specifications

PRODUCT WEIGHT	LOAD CAPACITY	COLORS	FINISH	PACKAGE SIZE (WxHxD)	SHIP WEIGHT	UPC CODE	PACKAGE CONTENTS
5.1lb (2.3kg) WA1	50lb (22.7kg) per shelf	Black	Tempered Glass	18.9" x 5.5" x 2.4"	7.3lb (3.3kg)	WA1 0815885012891	Glass shelves, wall mounting hardware, product manual.
10.1lb (4.6kg) WA2				34.6" x 5.5" x 2.4"	14.6lb (6.6kg)	WA2 0815885013034	
15.4lb (7kg) WA3				50.4" x 5.5" x 2.4"	22lb (9.9kg)	WA3 0815885013041	

Visit [crimsonav.com](http://crimsonav.com) to see the full line of vidamounts LCD/plasma, projector and TV/monitor mounts. © 2010 Crimson AV LLC. All rights reserved.