

VW4600G3 Video Wall Mount

For Video Wall Displays up to 600 x 400 VESA

Best in Class Video Wall Mount

- 6 points of micro-adjustment
- 3" Depth adjustment
- 1" Plumb adjustment
- 1" Vertical adjustment and leveling
- 11" Service mode extension from wall for wiring & alignment
- Push in - Pop out™ technology
- Lateral shift
- Integrated dual keyed lock system

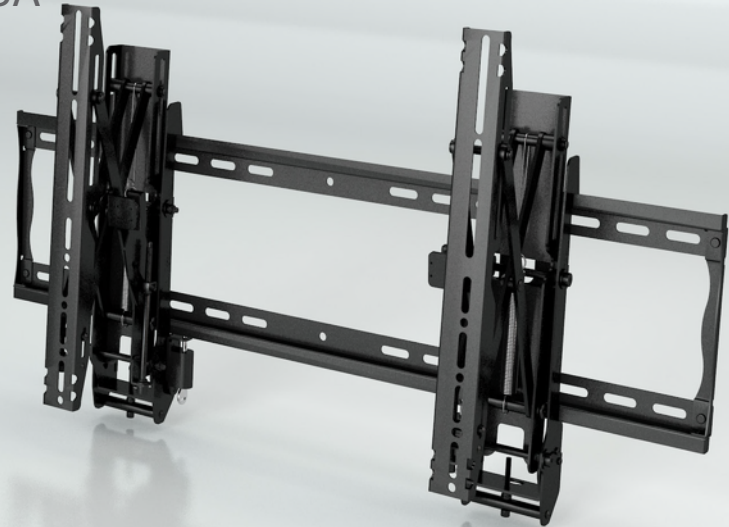

Model	TV Size	VESA	Depth	Max Load
VW4600G3	40" or larger	Up to 600x400	3.85" Min - 6.8" Max	200 lb

SERVICE MODE

11" Extension From Wall

Gives installer 11" of clearance for wiring and service.



Depth Adjustment

3" Depth Micro-Adjustment

In addition to the 4-corner plumb adjustment of G2, the G3 adds an independent micro-adjustment for regulating depth of the display relative to the wall.

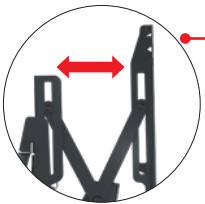

LOCK & KEY SECURITY

Proprietary Dual Lock System

Crimson-specific keyed locking system with keys that can not be duplicated.

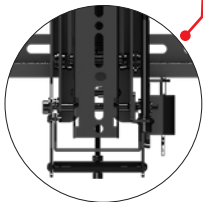

LATERAL SHIFT

Along the Wall Plate

Laterally slide TV during installation. Amount of lateral shift depends on the VESA hole pattern of the display.

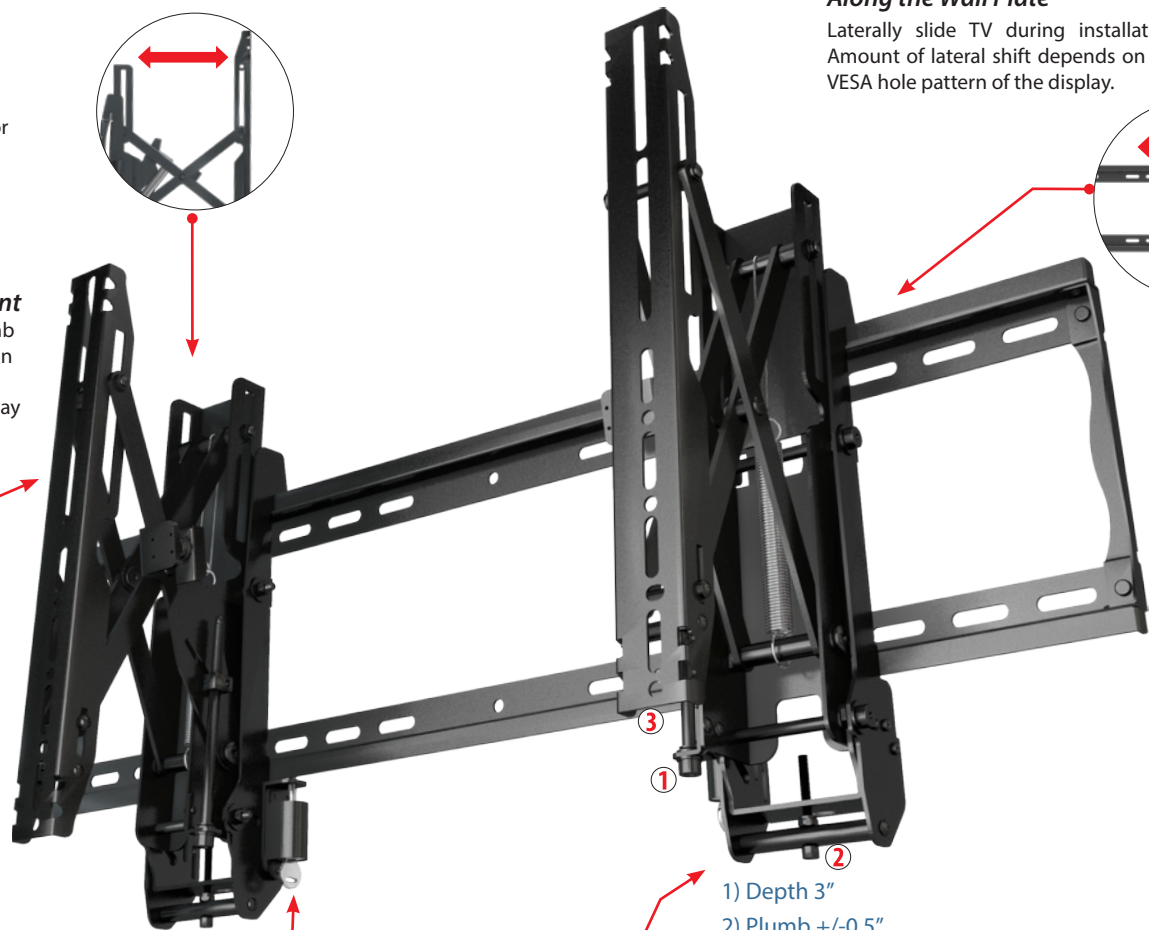
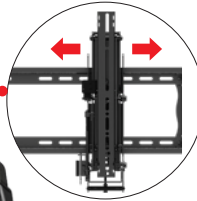

- 1) Depth 3"
- 2) Plumb +/-0.5"
- 3) Leveling +/-0.5"

ADJUSTMENTS IN ONE LOCATION

6 Conveniently Located Adjustment Points

All 6 micro-adjustment points are located on the bottom of the mount for easy access. 6mm standard hex driver is included.

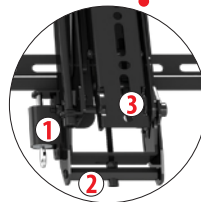

VW4600G3 Video Wall Mount

For Video Wall Displays up to 600 x 400 VESA

1-866-MOUNT-TV
www.crimsonav.com



The third generation of our best in class video wall mount system builds on the proven success of our previous models to deliver not only more points of adjustment but also increased adjustment range. In addition to vertical, horizontal, and plumb adjustments, the VW4600G3 allows for nearly 3" of depth micro-adjustment for ultimate ease in video wall alignment especially in instances where walls are uneven.

Attribute	Value
Monitor size	40" or larger
Orientation	Landscape
Weight capacity	200 lb
Max mounting pattern	783x402mm
VESA mounting patterns	200x200mm through 600x400mm
Post-installation leveling	+/- 0.5" (1" total)
Plumb Micro-Adjustment	+/- 0.5" (1" total)
Depth Micro-Adjustment	2.95" total depth
Depth from wall	Min 3.85" Max 6.8"
Extension	11" extension from wall during service
Security	Proprietary keyed alike lock and key system
Packaging Dimensions	35.5" x 12.75" x 4.75"
Shipping weight	22 lb
Construction	High-grade cold rolled steel
Product finish	Scratch resistant epoxy powder coat
Color	Black
Model number	VW4600G3
Warranty	Lifetime

