

Maximum load rating: 6-30 lbs

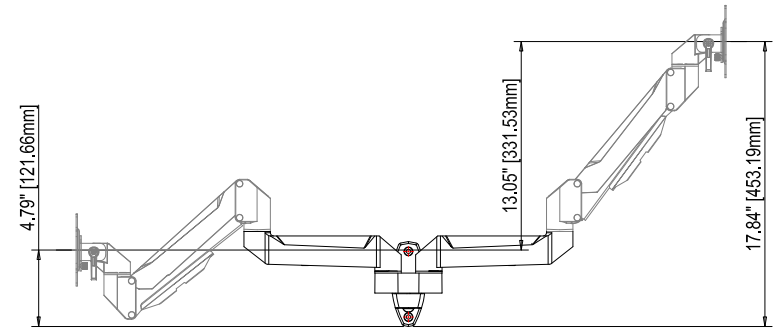

THE INFORMATION CONTAINED IN THIS DRAWING IS THE SOLE PROPERTY OF CRIMSON AV LLC. ANY REPRODUCTION IN PART OR AS A WHOLE WITHOUT THE WRITTEN PERMISSION OF CRIMSON AV LLC IS PROHIBITED

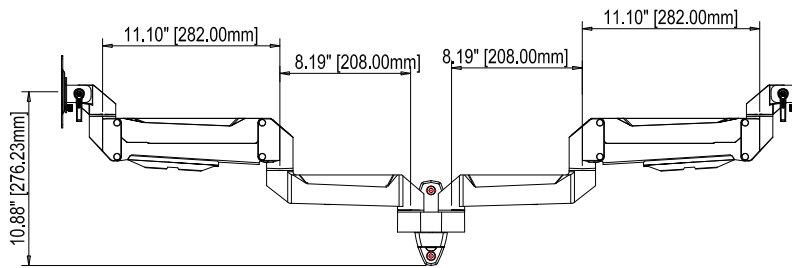
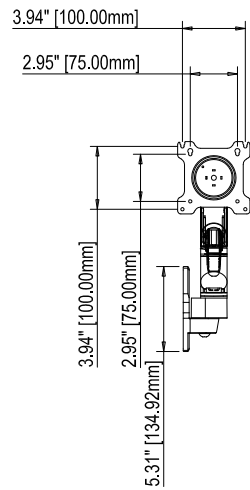
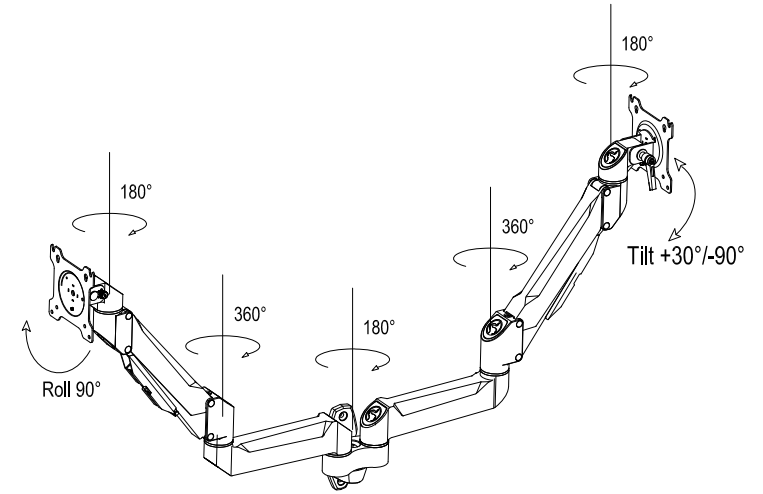
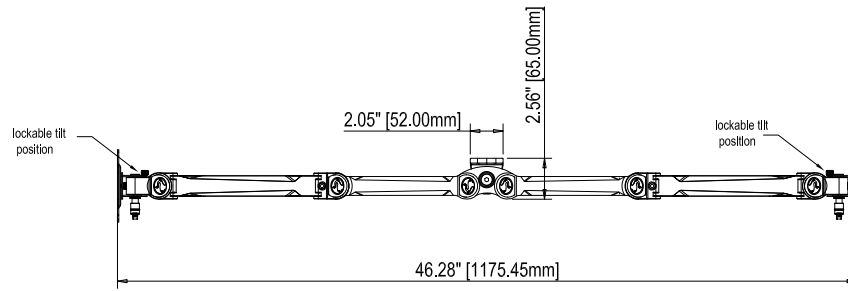

CRIMSON AV LLC.

PRODUCT ORDER NUMBER: DSA22W
PHONE: 1-866-668-6888

DSA22W

Scale=1:1

Crimson AV LLC.
www.crimsonav.com

TITLE: DSA22W

SIZE DWG.NO. DSA22W