

Maximum load rating: 200 lbs

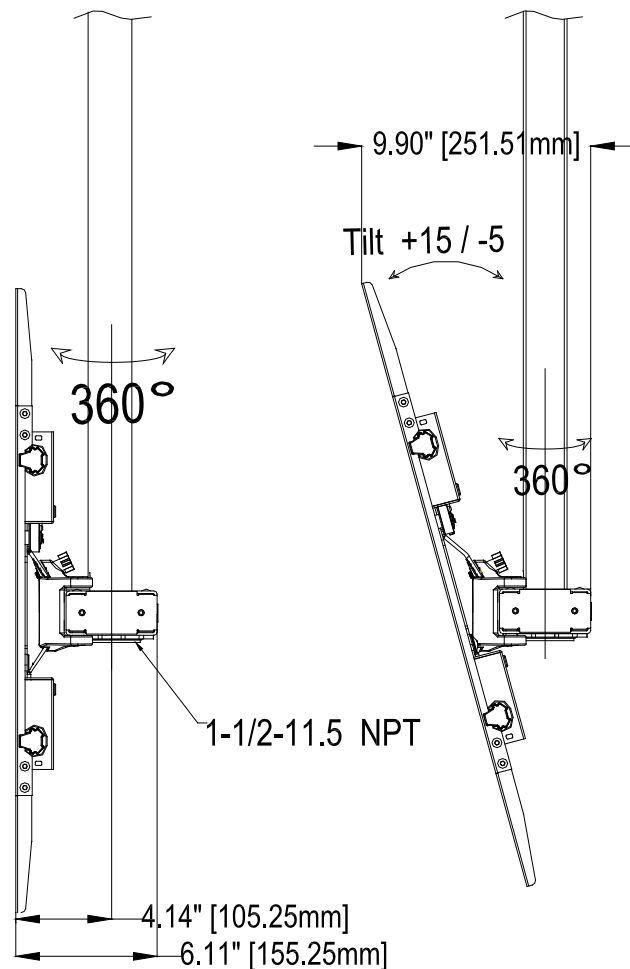

THE INFORMATION CONTAINED IN THIS DRAWING IS THE SOLE PROPERTY OF CRIMSON AV LLC. ANY REPRODUCTION IN PART OR AS A WHOLE WITHOUT THE WRITTEN PERMISSION OF CRIMSON AV LLC IS PROHIBITED

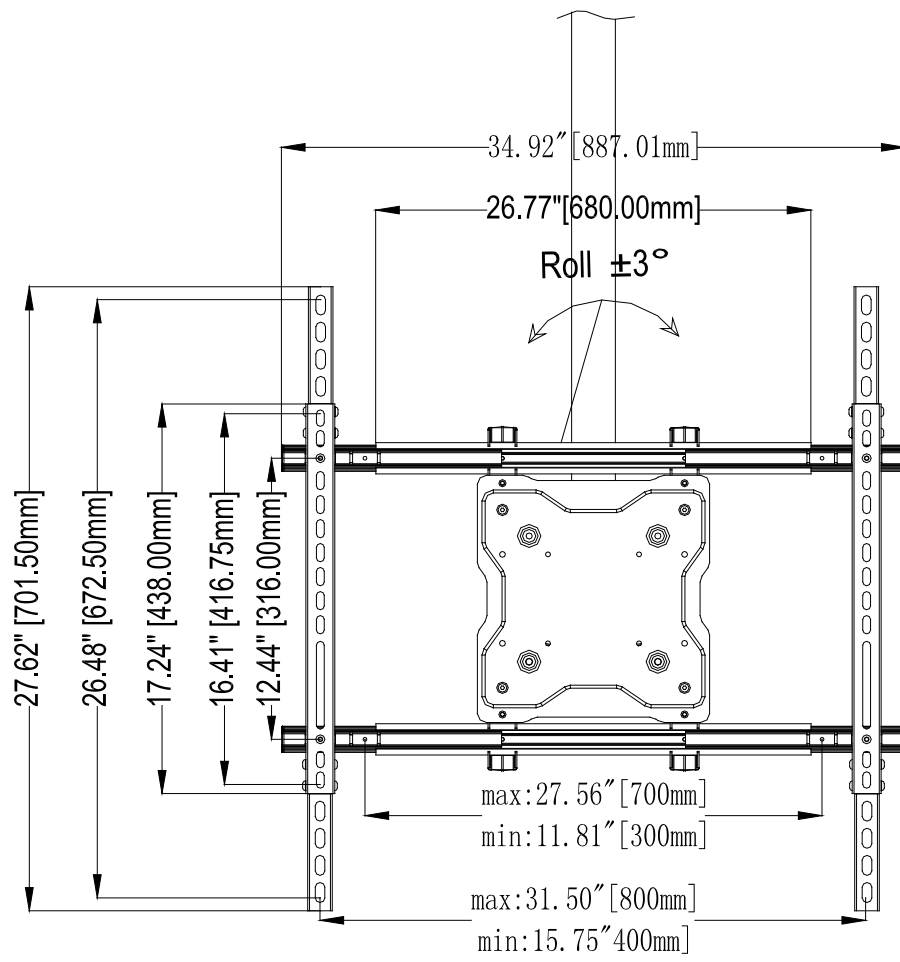

CRIMSON AV LLC.
PRODUCT ORDER NUMBER: **C65**
PHONE: **1-866-668-6888**

Scale=1:1

Crimson AV LLC. www.crimsonav.com	
TITLE: C65	
SIZE B	DWG.N.O. C65