





Professional Solutions - Unrivalled Value

Screen adapter and ceiling box assembly for mounting 32" to 55" flat panel screens. Continuous tilt of 15° forward with 360° rotation. Makes a secure installation quick and easy, simply hang the screen and turn the pre-assembled securing screws to lock in place. Compatible with all 1.5" NPT threaded pipe.

 32" - 55" / 81cm-140cm

 100 LB / 45 KG

■ **Various Screen Sizes**

Fits most 32" to 55" flat panel screens weighing 100lb or less.

■ **Multi-angle Positioning**

Up to 15° of continuous tilt and 360° rotation.

■ **Commercial Grade**

Ideal for commercial and retail settings.

■ **Easy Installation**

Pre-assembled securing screw makes installation fast and easy.

■ **Standard Interface**

Mounts to any 1.5" NPT threaded pipe.

■ **VESA Compatible**

Works with any hole pattern up to 400mm (15.7") x 400mm (15.7") in height.

■ **Included Hardware**

Pre-sorted hardware pack for easy component selection and installation (hardware for installation to wood studs or concrete surfaces included).

Functional Specifications

Tilt: +15°/-5°

Rotation: 360°

Mounting Surfaces: 1.5" NPT Threaded connection.

Max Mounting Pattern:

400mm (15.7") width

400mm (15.7") height

Load Capacity: 100 LB / 45 KG

Warranty: Limited 10 Years

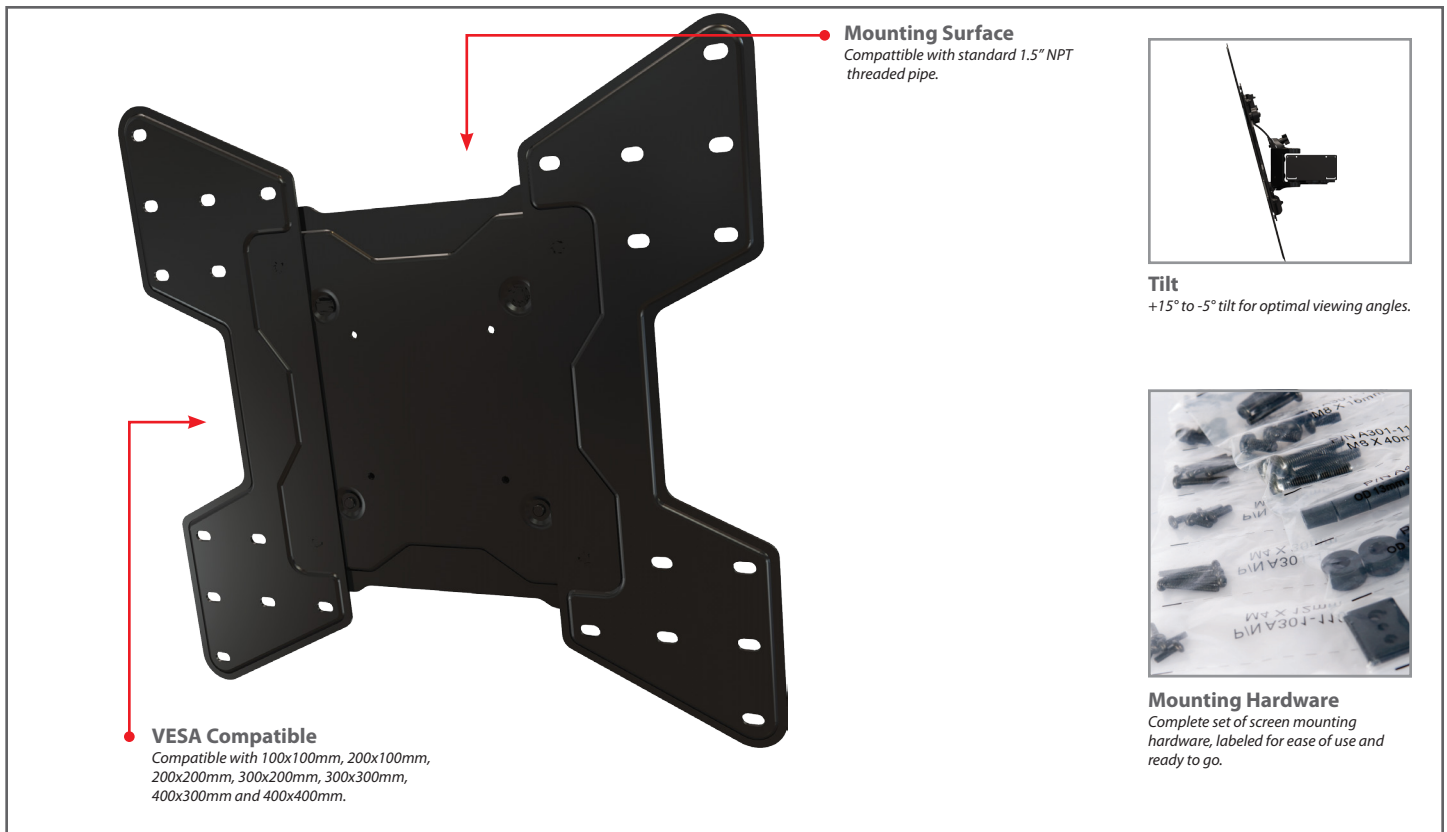

Mounting Surface

Compatible with standard 1.5" NPT threaded pipe.



Tilt

+15° to -5° tilt for optimal viewing angles.



Mounting Hardware

Complete set of screen mounting hardware, labeled for ease of use and ready to go.

VESA Compatible

Compatible with 100x100mm, 200x100mm, 200x200mm, 300x200mm, 300x300mm, 400x300mm and 400x400mm.



Single Flat Panel Ceiling Mount

For 32" to 55" (81-140cm) LCD and Plasma TV's

C55V

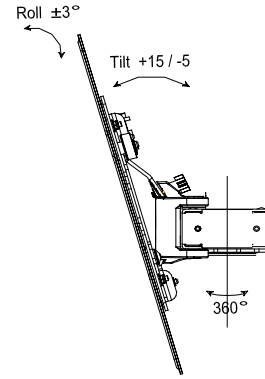
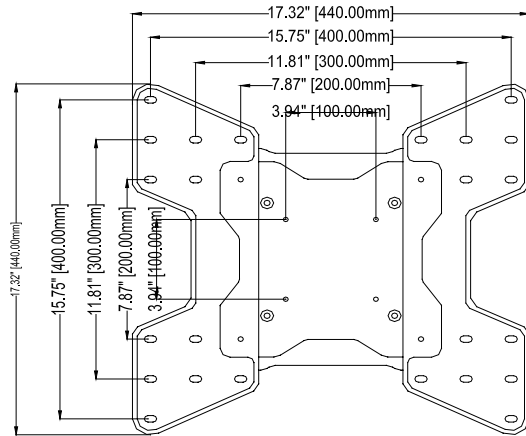

Product Specifications

Package Specifications

PRODUCT WEIGHT	LOAD CAPACITY	COLORS	FINISH	PACKAGE SIZE (WxHxD)	SHIP WEIGHT	UPC CODE	PACKAGE CONTENTS
14.8 lb (6.7 Kg)	100lb (45 Kg) total	Black	Scratch resistant powder coating	19.7" x 19.7" x 7.1" (500 x 500 x 180mm)	19.2 lb (8.7 Kg)	C55V (Black) 0815885010132	Mount, screen mounting hardware, product manual.

Mounting Interface

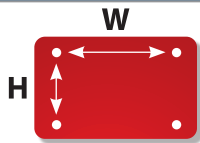

Max Mounting Pattern
 400mm (W) x 400mm (H)

VESA

W	100mm	200mm	200mm	300mm	300mm	400mm	400mm	400mm
H	X	X	X	X	X	X	X	X
	100mm	100mm	200mm	200mm	300mm	200mm	300mm	400mm

Accessories

Suspended Ceiling Adapters



CAS1W

For mounting above a false ceiling tile. 13" of lateral shift for fast project adjustment. Compatible with all 1.5" NPT threaded pipe.



CAS2W

Replaces a standard 2' x 2' grid. 13" of lateral shift for fast project adjustment. Compatible with all 1.5" NPT threaded pipe.

Structural Ceiling Adapters



CA1

Wood Single Joist / Concrete



CA2

Wood 16" Double Joist / Concrete



CA4

General Purpose 4x4"



CA8

General Purpose 8x8"

Truss Ceiling Adapter



CAT3

Mounts to round, square and rectangular trusses from .75" up to 3" in diameter and is compatible with all 1.5" NPT threaded pipe.

Vaulted Ceiling Adapter



CAV1

For installation on cathedral or vaulted ceilings. Adjusts up to 94° and is compatible with all 1.5" NPT threaded pipe.

Unistrut Ceiling Adapters



CAU1

Bracket and hardware for mounting to single 1-5/8"x1-5/8" Unistrut.



CAU4

Bracket and hardware (4x4) for mounting to standard 1-5/8"x1-5/8" dual channels spaced on 2.25" centers.



CAU8

Bracket and hardware (8x8) for mounting to standard 1-5/8"x1-5/8" dual channels spaced on 6" centers.

Unistrut Bolts

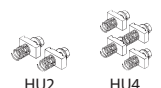

HU2 (2 Bolts)

HU4 (4 Bolts)

3/8" bolts and spring nuts for mounting ceiling brackets to standard 1-5/8"x1-5/8".

Fixed Columns

Static ceiling columns for use with all ceiling adapters using standard 1.5" NPT interfaces. Connectors (sold separately) give ability to extend drop lengths by connecting two or more columns. Cable management with a completely open interior.



BLACK	DROP
E06	6"
E1	12"
E018	18"
E2	2'
E3	3'
E4	4'
E5	5'
E6	6'
E7	7'
E8	8'
E9	9'
E10	10'

Adjustable Columns

Adjustable extension columns designed for use with all ceiling adapters using standard 1.5" NPT interfaces. Column allows for flexibility with quick 1" incremental drop length adjustments and cable management with a completely open interior. Connectors (sold separately) give ability to extend drop lengths by connecting two or more columns.



BLACK	DROP
EA0611	6"-11"
EA01218	12"-18"
EA01824	18"-24"
EA23	2'-3'
EA24	2'-4'
EA35	3'-5'
EA46	4'-6'
EA57	5'-7'
EA68	6'-8'
EA79	7'-9'
EA810	8'-10'
EA911	9'-11'
EA1012	10'-12'

Visit crimsonav.com to see the full line of vidamounts LCD/plasma, projector and TV/monitor mounts. © 2010 Crimson AV LLC. All rights reserved.