





Professional Solutions - Unrivalled Value

Articulating arm holds screen 2.9" from wall and extends up to 15.4" for variable viewing angles. Smooth tilt adjustments of 15° forward and 5° back with a locking knob for a variety of viewing angles. 5° side to side roll for perfect screen positioning. Makes a secure installation quick and easy, simply hang the screen and turn the pre-assembled securing screw to lock in place. Integrated cable management for clean look.

 13"-40" / 33cm-101cm

 80 LB / 36 KG

■ **VESA Compatible**

Fits VESA hole patterns 75x75mm, 100x100mm, 200x100mm and 200x200mm.

■ **Extendable**

Extends from 2.9" to 15.4"

■ **Screen Size**

Fits most 13" to 40" flat panel screens weighing up to 80lb (36kg).

■ **Tilt**

Pre-tensioned tilt mechanism allows for smooth tilt adjustment of 15° forward and 5° back.

■ **Easy Installation**

Pre-assembled securing screw makes installation fast and easy.

■ **Cable Management**

Integrated cable management for clean look.

■ **Included Hardware**

Pre-sorted hardware pack for easy component selection and installation (hardware for installation to wood studs or concrete surfaces included).

Functional Specifications

Depth from wall: 2.9" (73mm)

Swivel: 180° (3 joints)

Tilt: +15°/-5°

Mounting Surfaces: Wood stud, concrete & cinder block (with included hardware). Metal Stud (requires accessories).

Max Mounting Pattern:

200mm (7.9") width

200mm (7.9") height

Load Capacity: 80 LB / 36 KG

Warranty: Limited 10 Years

Pre-Installed Securing Screw
Screen simply hooks in place. Pre-assembled securing screw makes installation fast and easy.



Full Range of Motion
3 pivot joints for variable viewing angles.

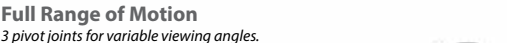

Tilt
Pre-tensioned tilt mechanism allows 15° forward and 5° backward tilt for optimal viewing angles.



VESA Compatible
Fits VESA hole patterns 75x75mm, 100x100mm, 200x100 and 200x200mm.

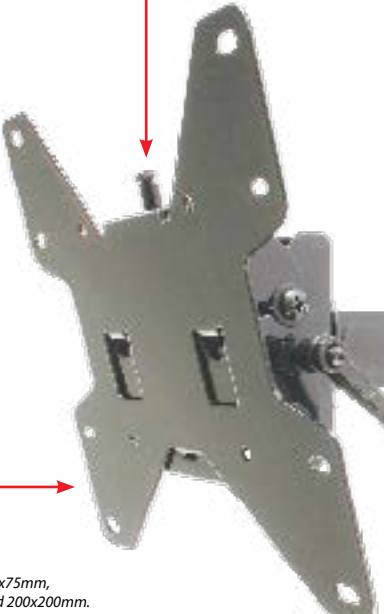

Cord Management
Integrated cord management for clutter-free installation.





Full Motion Articulating Wall Mount

For 13" to 40" (33-101cm) LCD, LED and Plasma TV's

A37F (BLACK)
A37FS (SILVER)

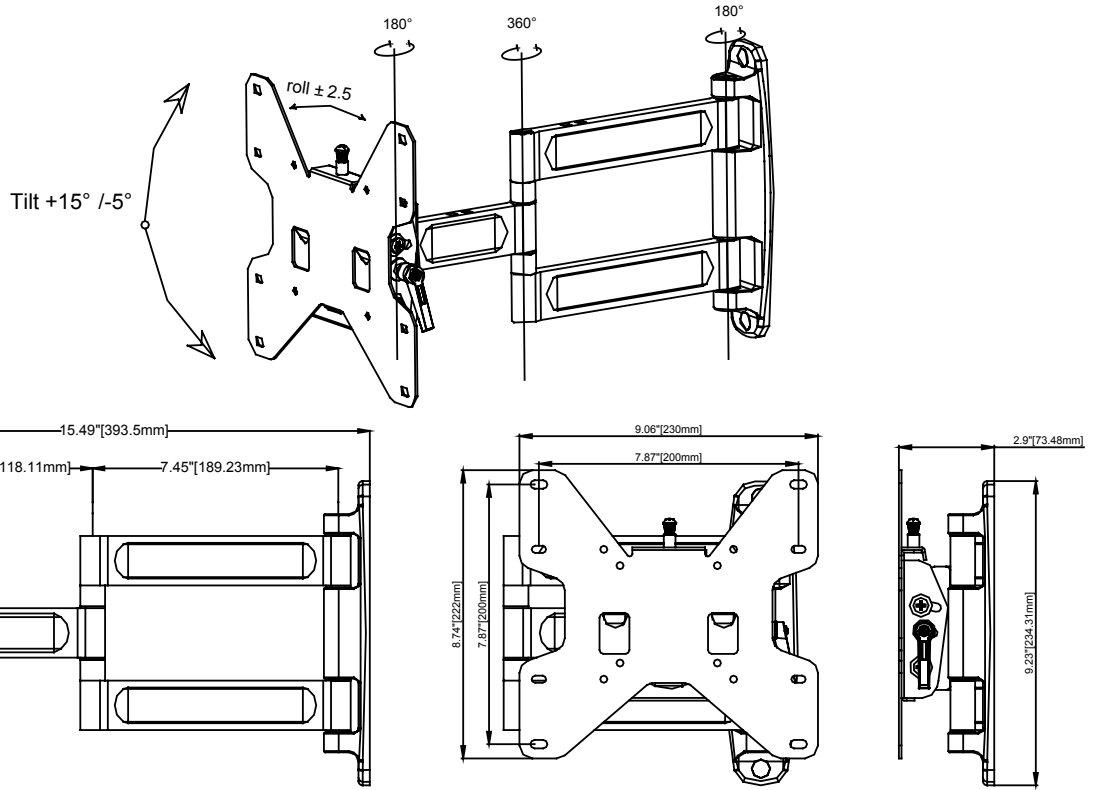

Product Specifications

Package Specifications

PRODUCT WEIGHT	LOAD CAPACITY	COLORS	FINISH	PACKAGE SIZE (WxHxD)	SHIP WEIGHT	UPC CODE	PACKAGE CONTENTS
5.5lb (2.5kg)	80lb (36kg)	Black Silver	Scratch resistant powder coating	11.1" x 10.2" x 4.3" (282 x 260 x 109 mm)	6.5lb (2.9kg)	A37F (Black) 0815885010439 A37FS (Silver) 0815885010446	Mount, wall and screen mounting hardware, product manual.

Mounting Interface

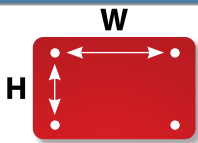

Max Mounting Pattern
200mm (W) x 200mm (H)

VESA	W	H	75mm	100mm	200mm	200mm
	X	X	X	X	X	X
	X	X	X	X	X	X

Accessories

Toggle bolts (for metal stud installation)



- HT2 - 2 Pack
- HT4 - 4 Pack
- HT6 - 6 Pack

Use when installing into metal stud.

On-wall Cable Management



- WA1 - 1 Shelf
- WA2 - 2 Shelves
- WA3 - 3 Shelves

Component shelf and on-wall cable routing system. Hides cables inside internal channels for a clean look.

Shelving



WF1 - 1 Shelf

Single-stud mountable component shelf.

Visit crimsonav.com to see the full line of vidamounts LCD/plasma, projector and TV/monitor mounts. © 2010 Crimson AV LLC. All rights reserved.